

BACK VIEW

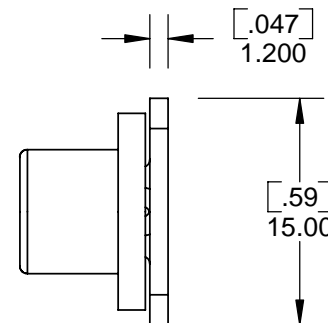

BASEPLATE SHOWN APPROX SIZE  
[ 1:1 SCALE ]

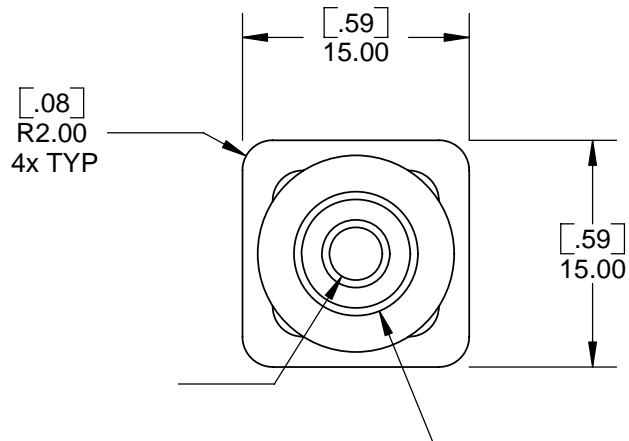

www.rotaloc.com  
info@rotaloc.com

1.888.768.2652  
1.303.948.5434

THIS DOCUMENT IS PROPRIETARY AND CONFIDENTIAL

THE INFORMATION CONTAINED IN THIS DRAWING IS THE SOLE PROPERTY OF ROTALOC INT'L. ANY REPRODUCTION IN PART OR AS A WHOLE WITHOUT THE WRITTEN PERMISSION OF ROTALOC INT'L IS STRICTLY PROHIBITED.

DRAWING LAYOUT & CONTENTS COPYRIGHT© 2006 - ROTALOC INT'L

ROTALOC® IS A REGISTERED TRADEMARK OF ROTALOC INT'L, LLC

MATERIAL

PLATING

UNLESS OTHERWISE SPECIFIED:

DIMENSIONS ARE IN:  
[INCHES]  
MILLIMETERS

TOLERANCES:

ANGULAR: ± 1°  
TWO PLACE DECIMAL: ± [.006"] .15  
THREE PLACE DECIMAL: ± [.004"] .100

DIMENSIONS & TOLERANCES  
DO NOT INCLUDE PLATINGS OR COATINGS

INTERPRET GEOMETRIC  
TOLERANCING PER: ASME Y14.5

DO NOT SCALE DRAWING

NAME

DATE

DRAWN

CHECKED

COMMENTS:

ROTALOC INT'L

TITLE:

SIZE

**A**

DWG. NO.

**F2-B15**

REV

WEIGHT:

SHEET 1 OF 1